



PERGAMON

Available online at www.sciencedirect.com

SCIENCE @ DIRECT®

International Journal of
**Multiphase
Flow**

International Journal of Multiphase Flow 29 (2003) 1237–1247

www.elsevier.com/locate/ijmulflow

Pool boiling of nano-fluids on horizontal narrow tubes

Sarit K. Das ^{a,*}, Nandy Putra ^b, Wilfried Roetzel ^b

^a *Heat Transfer and Thermal Power Laboratory, Mechanical Engineering Department,
Indian Institute of Technology, Madras 600036, India*

^b *Institut für Thermodynamik, Universität der Bundeswehr, Hamburg D-22039, Germany*

Received 1 October 2002; received in revised form 14 May 2003

Abstract

The search for new cooling medium does not limit itself to liquids alone. Liquid–solid suspensions have got a good promise in convective cooling applications. Suspension of common fluids with particles of the order of nanometers (typically 10–100 nm) in size are called ‘nano-fluids’ which have been found to enhance the heat transfer capability of the base fluid to a considerable extent. With very small volume fraction, such particles are capable of increasing the thermal conductivity and convective heat transfer significantly without the known problems encountered in common slurries such as clogging, erosion, sedimentation and increase in pressure drop. A recent study on pool boiling on a tube of large diameter (20 mm) shows that the nano-particles degrade the boiling performance with increasing particle concentration pushing up the wall superheat for a given heat flux. The present investigation focuses on an experimental study of pool boiling in water–Al₂O₃ nano-fluids on horizontal tubes of small diameter. Tubes of small diameter are of interest in efficient cooling applications such as those in electronic modules or LASER devices where miniaturisation is taking place at a rapid pace. However pool boiling of narrow horizontal tubes (4 and 6.5 mm diameter) is qualitatively different from the large diameter tubes due to difference in bubble sliding mechanism. It is found that at the range of narrow tubes the deterioration in performance in boiling is less compared to large industrial tubes which makes it less susceptible to local overheating in convective applications. Thus, the present study on boiling of nano-fluids can act as a guidance for the use of these engineered fluids in the above applications.

© 2003 Elsevier Ltd. All rights reserved.

1. Introduction

In recent times heat transfer technology is confronted with increasing demand of cooling applications of miniaturised high heat flux components. Applications such as LASER diagnostics,

* Corresponding author. Tel.: +91-44-4458550.

E-mail address: sarit_das@hotmail.com (S.K. Das).

superconducting magnets and most importantly superfast computing are posing tremendous challenge to thermal management. Usually air based cooling systems are more common and reliable but they are inadequate for high heat flux applications where liquid cooling is preferred. The cooling liquids usually used are chilled water, refrigerants or cryogenes depending on the requirement of heat removal. Looking at the requirement, it makes sense to consider alternatives such as fluid suspensions of ultrafine solid particles. The fluids with suspended solid particles have not been considered as an alternative for heat transfer applications so far due to associated technological problems such as sedimentation, clogging, erosion, fouling and increase of pressure drop. However in recent times a fresh look has been cast on these fluid–solid suspensions with particles of nano-meter size which have been named as ‘nano-fluids’ by Choi (1995). The erosion, clogging and pressure drop problems are also greatly reduced due to small particles and the small volume fraction (usually 1–5%) required and the stability of such fluids against sedimentation is remarkably improved. Lee et al. (1999) reported a substantial enhancement of thermal conductivity of water and ethylene glycol based nano-fluids with Al_2O_3 or CuO nano-particles at room temperature. In a recent study (Das et al., 2001) the present authors have shown that the enhancement of thermal conductivity of nano-fluids increases even more at elevated temperature which makes it more attractive for cooling at high heat flux applications. This enhancement of thermal conductivity received an impressive breakthrough when Eastman et al. (2001) reported an increase of thermal conductivity by an outstanding 40% with only 0.04% of nano-particles of pure copper having average size less than 10 nm. The above works indicate that usual theories of thermal conductivity of suspensions such as the Hamilton and Crosser (1962) model fail in case of nano-fluids. A satisfactory theory is yet to evolve.

However, for heat transfer applications, the enhancement of thermal conductivity is not the only concern, the real worth of such fluids as coolants can only be examined under convective conditions. Ahuja (1975) and Liu et al. (1988) have shown that performance of suspensions even with micrometer size particles are encouraging under convective conditions. The proposition of dispersion model by Xuan and Roetzel (2000) can be a useful tool in theoretical modelling of nano-fluids under convective conditions. While using nano-fluids for convective cooling, one cannot overlook the need of proper knowledge of its boiling characteristics. This is because during convective heat transfer with high heat flux local boiling condition may be reached. It is important to know the behaviour of nano-fluids under such conditions to avoid unwanted effects if any. The present authors have carried out an experimental study (Das et al., 2003) of pool boiling characteristics of water– Al_2O_3 nano-fluid under atmospheric conditions on a tube of large diameter (20 mm). The study shows that the nano-particles degrade the boiling performance systematically with increasing particle concentration resulting in an increase of wall superheat for a given heat flux. The deterioration in boiling performance is observed to be more drastic at a higher surface roughness.

The present paper is aimed at understanding the pool boiling of nano-fluids in the regime of small diameter tubes (4 and 6.5 mm) which are on the one hand more important for application in miniaturised heat sources, on the other hand they are different from the usual tubes with respect to pool boiling due to the closeness of bubble and tube diameter and a consequent deviation in bubble sliding mechanism. Thus, the present study can act as a guidance for the use of these fluids in the applications where high heat flux is associated with smaller dimensions of the components.

2. Characterisation of nano-fluid

Although a number of combinations of base fluid and particle can be used for nano-fluids, in the present investigation, water– Al_2O_3 particles nano-fluids have been used. This is due to the fact that the boiling characteristics of the base fluid water is widely known and the enhancement of thermal conductivity of water– Al_2O_3 nano-fluids has already been studied (Das et al., 2001). The particles were supplied by nano-phase Technologies Corporation, IL (USA) produced by physical vapour deposition technique. In the powder state they form loose agglomerates as shown by transmission electron microscopy (TEM) photo in Fig. 1. The dispersion of the particles in water was carried out by using ultrasonic vibration for 4 h. It was observed that they break down to smaller sizes when dispersed in water. Fig. 2 shows the TEM picture of dispersed particles by drying a dilute dispersed suspension on silicon wafers. The volume weighted average particle size was found to be 58.4 nm. The distribution of particle size is shown in Fig. 3. It was found that the resulting suspension is quite stable. At higher concentration (4%) very nominal amount of sedimentation occurs after a time (6 h) much greater than the time required for boiling experiment.

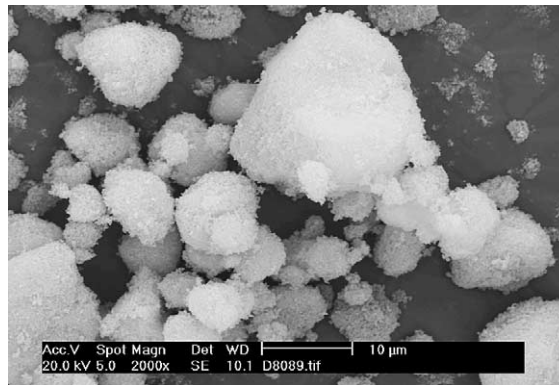

Fig. 1. TEM of nano-particles agglomerates.

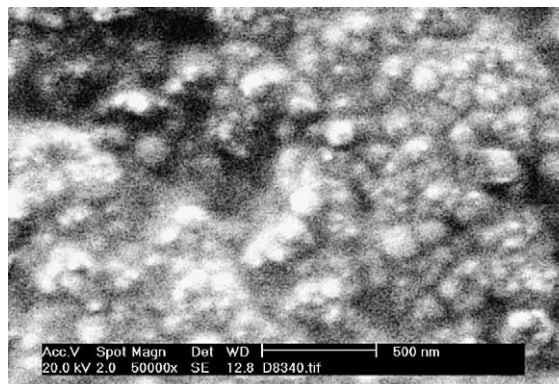

Fig. 2. TEM of dispersed nano-particles.

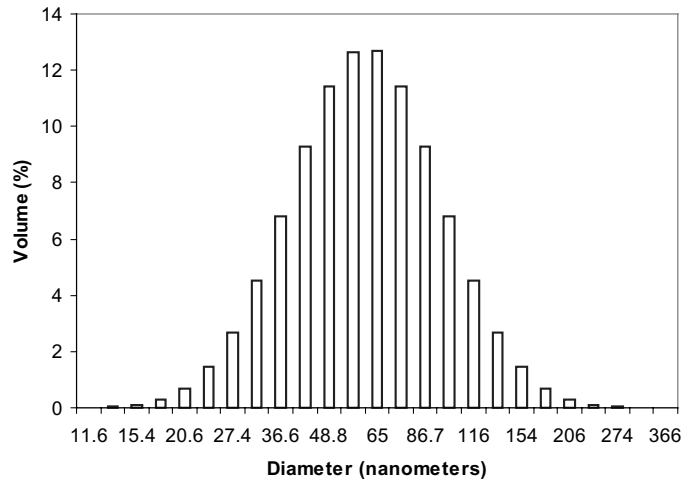

Fig. 3. Particles size distribution of the nano-particles.

To characterize the produced nano-fluid, first a rheological study was made. The measurement with a disc type rotating rheometer confirms a Newtonian behaviour of the nano-fluids used here but the viscosity was found to be higher compared to water as shown by Das et al. (2003). This rotating disc type rheometer contains a spring mounted base disc on which the fluid for which viscosity is to be measured is spread as a thin film and is touched by a rotating disc at the top. The top disc is attached to a spindle rotating with the help of a motor. For a given disc size and spindle speed the deflection of the spring will be proportional to the fluid viscosity. The instrument was first calibrated with water at different temperatures and finally measurement was made for nano-fluids. After each measurement it was ensured that particles were not sticking to the discs. Since surface tension is an important parameter in pool boiling, it was also measured by ring method and found to be unaffected by the presence of the particles.

3. Pool boiling experiment

3.1. Experimental setup

A simple experimental setup was designed keeping watch that the experiments for different nano-fluids and water were performed under identical conditions. The test section is shown in Fig. 4. It consists of 120 mm × 100 mm × 200 mm rectangular stainless steel vessel (1) with thick insulation (2) outside. The vessel has two cooling arrangements cascaded together. The first one (3) is a counter current copper condenser which on one hand connects the vessel directly to atmosphere maintaining an atmospheric pressure in it, on the other hand it also serves the purpose of after-cooling of any vapour which may try to escape as well as act as a vent to non-condensable gases. The cooling water from this vertical condenser is then circulated through an oval shaped copper coil (4) which performs the task of condensing the bulk of the vapour produced. This coil hangs from the roof of the vessel and is designed to cool the entire vapour at the maximum rate of

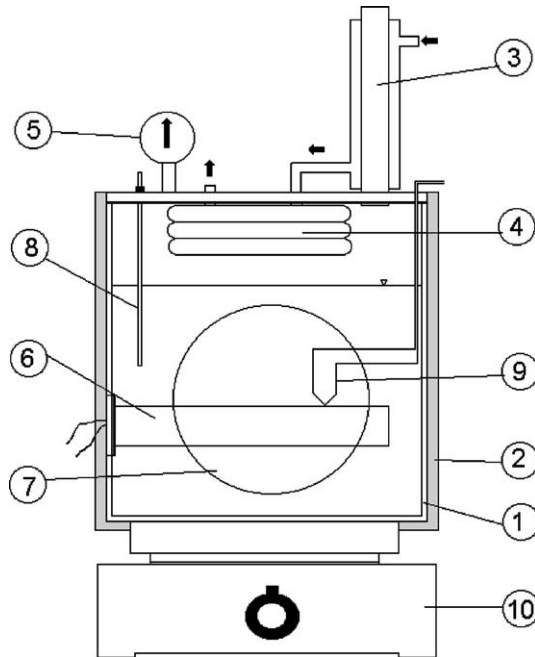

Fig. 4. Sketch of experimental apparatus.

evaporation. A pressure gauge (5) mounted at the top of the vessel checks the pressure at which boiling takes place. As boiling surface, cylindrical cartridge heaters (6) of different diameters are used. To observe the boiling characteristics during water experiments, round windows (7), with double walled glass (inner 8 mm and outer 6 mm thickness) were built on both the side walls. A sheathed 0.5 mm thick Chromel–Alumel (K-type) thermocouple (8) was inserted to observe the bulk liquid temperature during boiling. To measure temperature on the heating cartridge 10 K-type thermocouples of 0.1 mm thickness were welded at different radial and axial locations as indicated in Fig. 5. The radial locations are a, b, c and d and axial locations are 1, 2, and 3. The thermocouples were planted at locations 1a, 1b, 2a, 2b, 2c, 3c and 3d. The leads of the thermocouples were taken out from tip of the heater in a bunch (9). The vessel was mounted on a secondary disc type heater (10) to supply additional heat during the experiment with the smaller heaters with less power rating. The power supply to the primary heater was varied by a transformer and the power was recorded with a wattmeter. The thermocouples, pressure gauge and wattmeter were connected to a data logger which was in turn connected to a PC for recording and storage of data.

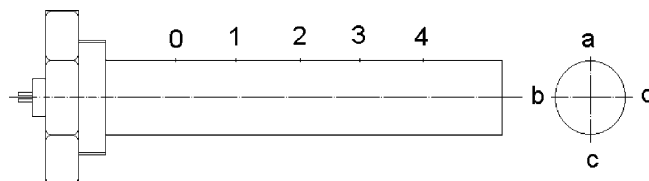

Fig. 5. Location of thermocouples on the heater.

In the present experiment stainless steel heaters of different diameters are used the surface of which are machine drawn. The surface characteristics of the heater were measured using a profilometer having a diameter tip of 2 μm and a sensitivity of 0.02 μm . The major parameters for characterisation of surface roughness are R_a and R_q (DIN 4762) which are defined as

$$R_a = \frac{1}{L} \int_0^L |Z(x)| dx \quad (1)$$

$$R_q = \sqrt{\frac{1}{L} \int_0^L Z(x)^2 dx} \quad (2)$$

A typical surface profile for the heaters is shown in Fig. 6. The typical measured values of roughness for the different heater surfaces are of the same order (0.37–0.45 μm). The surface roughness is measured before the boiling experiments. It is known from literature that the surface structure changes after boiling experiments with water because a lot of deposits are found. One may also have to consider the above phenomenon when one wants to measure the decrease of heat transfer due to nano-particle deposits on the surface. Stationary conditions were observed during the present experiments. Hence, the changes in the surface structure will be perhaps only in the microstructure and have no influence on the heat transfer results.

3.2. Experimental procedure and uncertainty

At the beginning a set of runs with doubly distilled water was made to ensure that the experimental results conform to those in literature for boiling on horizontal tubes as well as to check the repeatability of the experiment. The other objective of the water experiment was to observe the boiling process visually and get an idea of the change in the physical process with reducing diameter. During the experiments, temperatures were recorded at a number of thermocouple lo-

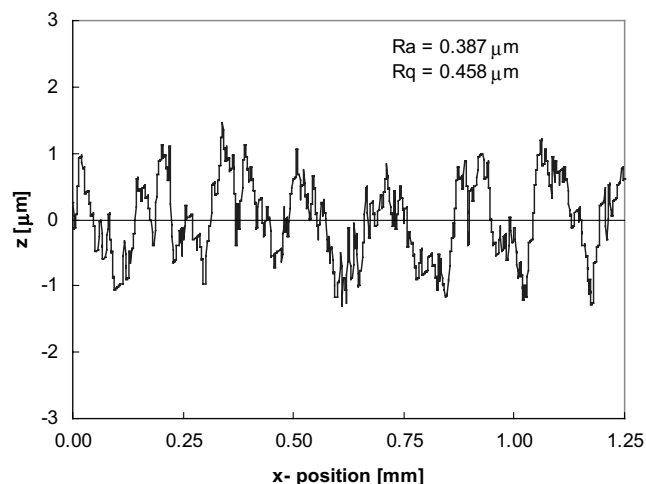

Fig. 6. Surface characteristics of the heater.

cations and an average was taken to designate the wall temperature. Before inserting, an infrared camera was used to check the uniformity of heating by switching on the heating in air. Prior to each experiment, the liquid was boiled for half an hour to drive out any dissolved gas. Experiment was first performed from the lowest to the highest power input and then it was carried out in the reverse direction to eliminate the possibility of any hysteresis using a sampling rate of 20 readings per second. During experiments with the nano-fluids, runs with the same nano-fluid were repeated with a run of boiling with pure water in between after cleaning the heater surface with a water jet to ensure that the particles were not sticking to the heating surface to change the surface characteristics.

The thermocouples on the heater surface with 0.1 mm diameter have an accuracy of 0.1 K and that for fluid temperature measurement with 0.5 mm diameter (for better stability within boiling fluid) is of 0.2 K accuracy. The wattmeter used for recording the power has got an accuracy of 10 W which is 1.25% at the lowest and 0.4% at the highest heat flux. The uncertainty in diameter measurement was 0.05 mm. A systematic error analysis was made to ascertain the measurement uncertainty which turned out to be 4.01% for surface heat flux. The uncertainty of temperature difference remains to be restricted to a maximum of 4%.

4. Results and discussion

Previous study (Das et al., 2003) shows that for nano-particle concentration of present range a very small decrease of 0.4 K in the boiling point occurs which is of the order of error in temperature measurement and can be neglected. The visual observation for pure water shows that for tube of large diameter (20 mm) bubbles sliding bubble regimes similar to those observed by a series of studies by Cornwell and Schüller (1982), Cornwell (1990) and the bubbles coalesce forming larger bubbles similar to those observed by Chun and Kang (1998). This shows that physically the boiling behaviour in the present apparatus is similar to that in the literature. However, the mechanism for the tubes of narrow diameter was found to be considerably different. For boiling on tubes of 4 and 6.5 mm diameter there seems to be less importance of sliding mechanism for larger bubbles which are comparable to the size of bubbles of boiling on 20 mm tube. This is because of the relatively small size of the tube which produces a large curvature of the surface which does not allow the sliding of larger bubbles but induce direct departure. However a large number of smaller bubbles are produced in a sustainable way here and they slide but to a relatively smaller distance. For these experimental runs with water, $Nu-Re_b$ data are plotted in Fig. 8 (this figure is placed after Fig. 7 for convenience of comparison with Fig. 9). The figure shows that for tube of larger diameter the data fits quite well to convective type correlation as suggested by Cornwell and Houston (1994) given by

$$Nu = C Re_b^{0.67} Pr^{0.4} \quad (3)$$

as well as the correlation suggested by Gorenflo (1997) in VDI Wärmeatlas. Here for both Nu and Re_b the tube diameter was used as the characteristic length and the measured viscosity of the nano-fluid at saturation temperature was used in the calculation of Re . The plot shows that for tube diameter between 4 and 6.5 mm the correlation does not perform very well which is expected because the above correlations were not developed for narrow tubes. The above results clearly

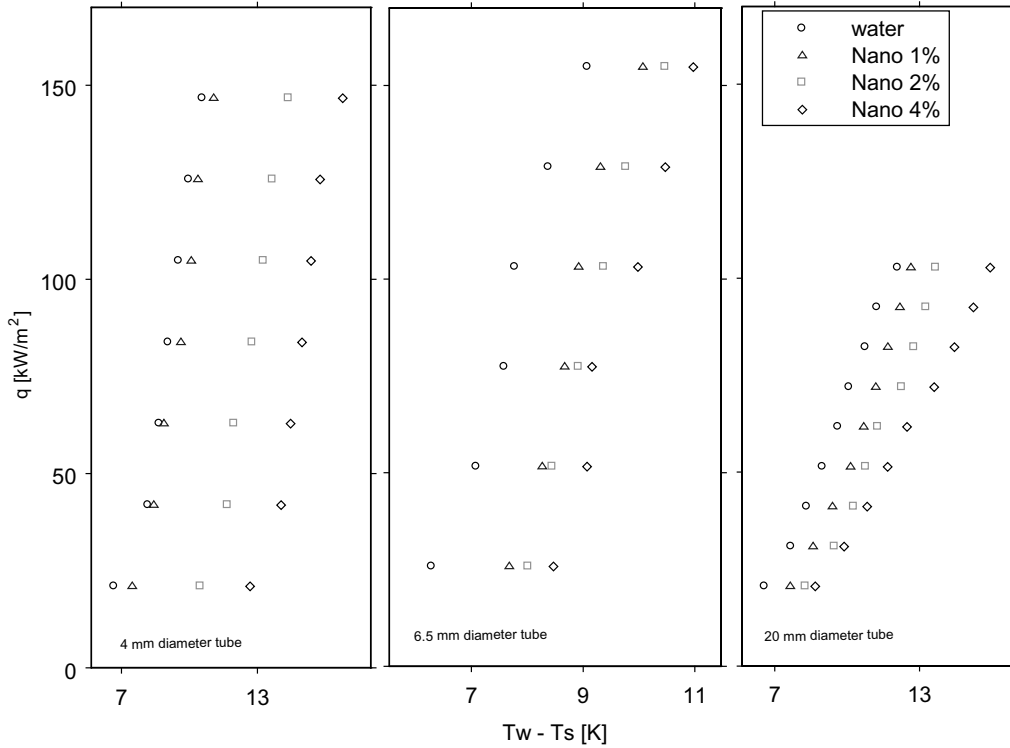

Fig. 7. $q-\Delta T$ curves for nano-fluids on tubes of different diameters.

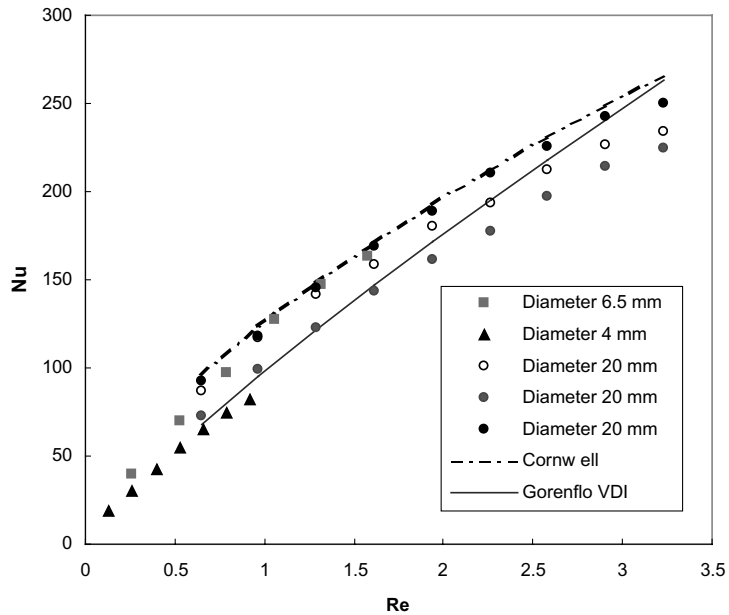

Fig. 8. Boiling characteristics of water on narrow tubes.

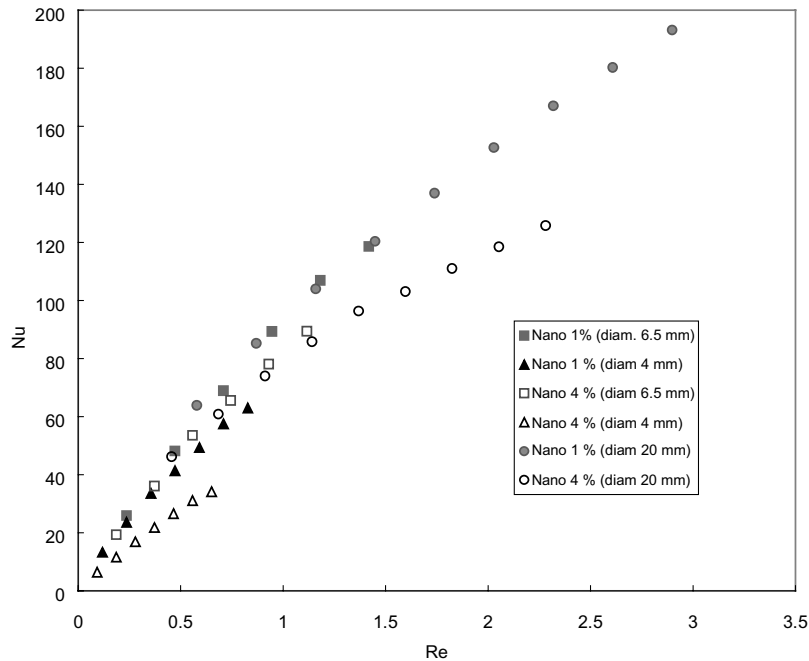

Fig. 9. $Nu-Re_b$ characteristics of nano-fluids.

indicate that the present apparatus is in good agreement with established boiling characteristics on horizontal tube whereas it reaffirms the need to develop correlations for boiling on narrow tubes. Subsequently, experiments were carried out to evaluate pool boiling with nano-fluids of 1%, 2% and 4% Al_2O_3 nano-particle concentration in water. Repeatable boiling characteristics of these nano-fluids in the $q-\Delta T$ form are presented in Fig. 7 for different tube diameters. These plots clearly indicate that, in general, the boiling performance of the base fluid deteriorates with the addition of nano-particles pushing the boiling curves to the right which means that the nano-fluid can cause harm to cooled surface if boiling occurs because it will give a higher surface temperature compared to water at the same heat flux similar to that observed earlier (Das et al., 2003). It has been observed that the shift of the curve to the right is not proportional to the particle concentration and it is strongly dependent on the tube diameter even for the similar values of surface roughness. For narrower heaters (4 and 6.5 mm) the shift of the curve is considerable and is almost of the same order over the entire range of heat fluxes. For 20 mm tube from 1% to 4% concentration a regular shift of the curve was observed at lower heat fluxes but at the upper part of the curves the difference between wall superheats for various particle concentrations was found to increase with increasing heat flux.

This depicts a regular tendency of deterioration of boiling character for nano-fluids which generally increase with particle concentration but the nature of deterioration is different in the narrow tube regime compared to the domain of large diameter tubes. The present study indicates that in the region of narrow tubes, the tube diameter plays a crucial role to decide the nature of this deterioration presumably for the change in bubble diameter and sliding bubble mechanism. In the range of narrow diameter the deterioration seems to be independent of flux which for the

larger diameter is strongly flux dependent. Also, for pure fluids the heat transfer increases with increase in viscosity but in the present case two competing phenomena are taking place, viz.,— increase of heat transfer due to viscosity, decrease of heat transfer due to decrease of nucleation site density by plugging off (micro) surface cavities by nano-particles. The results indicate that the latter effect is dominant over the former because the increase in viscosity is very marginal.

To further understand the effect of nano-particles on heat transfer dimensionless $Nu-Re_b$ plot is presented in Fig. 9. This figure indicates that for each particle concentration the $Nu-Re_b$ characteristics are different and shifted downwards. This is a general observation for all the tubes which indicates that the change in boiling characteristics of nano-fluids can neither be explained in terms of property change nor of changes in Nu and Re_b due to change in characteristic length (diameter). Particularly interesting to note are the results at low Re_b . The deterioration in boiling seems to be reducing between 20 and 6.5 mm but it reappears rather strongly at the lowest diameter of 4 mm. This is different from that at higher Re_b where the deterioration is rather strong at larger diameter. This effect can be explained by noting that for given tube diameter decrease in Re_b indicates decrease in heat flux and a consequent decrease in nucleation site density. With the decrease in nucleation sites the probability of plugging of these sites by nano-sized particles also decreases resulting in a decrease in the boiling deterioration. This happens at lower Re_b for lower diameter because at lower diameter the same Re_b corresponds to a higher heat flux giving a higher nucleation site density. At the intermediate diameter of 6.5 mm this effect is somewhat smaller because of the dominance of curvature effect which is known to give highest heat transfer coefficient near 8 mm diameter and decreases both above and below that diameter (Cornwell, 1990). In general, the change in $Nu-Re_b$ correlations is more drastic at higher Re_b for large diameter tubes than for narrow tubes. This indicates the danger of local overheating is smaller on narrow tubes compared to larger tubes for high heat flux applications when boiling point is reached for a nano-fluid. These observations are important from the application points of view. Nano-fluids are generating interest in heat transfer community for cooling of high heat flux applications. However, these fluids perform poorly when boiling occurs. The present study shows that the degradation in boiling is a strong function of tube diameter for narrow tubes.

5. Conclusion

The use of nano-fluids for cooling of high heat flux devices in modern electronics, computing and optical technology has been claimed to be a new possibility due to their enhanced thermal conductivity and capability of further enhancing convective process through particle dispersion. They have been found to be much improved compared to common slurries with respect to sedimentation, clogging and pressure drop. However under phase change conditions this possibility has been conclusively negated due to the fact that the presence of nano-particles deteriorates boiling performance with increase in particles concentration. In the present study it has been shown that the nature of this deterioration is different for the narrow tube regime compared to the large tube regime. From the application point of view, the present study shows that for convective cooling with nano-fluids, the extent of degradation in heat transfer is less for narrow tubes compared to large diameter tubes particularly at high heat flux if local boiling limit is reached. This makes nano-fluids more compatible to cooling narrow components with high heat flux. The

results can also be used for specific applications such as heat treatment of small components where a higher temperature of heated surface can be maintained and can be controlled by changing particle concentration or particle size.

Acknowledgement

This research work has been carried out during the stay of the first author in Hamburg under the Humboldt Research Fellowship which is gratefully acknowledged.

References

- Ahuja, A.S., 1975. Augmentation of heat transport in laminar flow of polystyrene suspension experiments and results. *J. Applied Physics* 46, 3408–3416.
- Choi, U.S., 1995. In: Siginer, D.A., Wang, H.P., (Eds.), *Enhancing thermal conductivity of fluids with nano-particles, developments and applications of non-Newtonian flows*, FED-vol. 231/MD-vol. 66. ASME, New York, pp. 99–105.
- Chun, M., Kang, M., 1998. Effects of heat exchanger tube parameters on nucleate pool boiling heat transfer. *J. Heat Transfer, Trans. ASME* 120, 468–476.
- Cornwell, K., 1990. The role of sliding bubbles in boiling on tube bundles. In: *Proceedings of Int. Heat Transfer Conference, Jerusalem*, pp. 455–460.
- Cornwell, K., Houston, S.D., 1994. Nucleate pool boiling on horizontal tubes: a convection-based correlation. *Int. J. Heat and Mass Transfer* 37 (suppl. 1), 303–309.
- Cornwell, K., Schüller, R.B., 1982. A study of boiling outside a tube bundle using high speed photography. *Int. J. Heat and Mass Transfer* 25, 683–690.
- Das, S.K., Putra, N., Thiesen, P., Roetzel, W., 2001. Temperature dependence of thermal conductivity enhancement for nano-fluids, *J. Heat Transfer, Transactions of the ASME*, in press.
- Das, S.K., Putra, N., Roetzel, W., 2003. Pool boiling characteristics of nano-fluids. *Int. J. Heat and Mass Transfer* 46, 851–862.
- Eastman, J.A., Choi, U.S., Li, S., Yu, W., Thompson, L.J., 2001. Anomalous increased effective thermal conductivities of ethylene glycol-based nano-fluids containing copper nano-particles. *Applied Physics Letter* 78, 718–720.
- Gorenflo, D., 1997. *Behältersieden*, section Hab, VDI-Wärmeatlas, eighth ed. VDI Verlag GmbH, Düsseldorf.
- Hamilton, R.L., Crosser, O.K., 1962. Thermal conductivity of heterogeneous two component systems. *I & EC Fundamentals* 1, 187–191.
- Lee, S., Choi, U.S., Li, S., Eastman, J.A., 1999. Measuring thermal conductivity of fluids containing oxide nano-particles. *ASME J. Heat Transfer* 121, 280–289.
- Liu, K.V., Choi, U.S., Kasza, K.E., 1988. Measurement of pressure drop and heat transfer in turbulent pipe flows of particulate slurries, Argonne National Laboratory Report, ANL-88-15.
- Xuan, Y., Roetzel, W., 2000. Conceptions for heat correlation of nano-fluids. *Int. J. Heat and Mass Transfer* 43, 3701–3707.